

User Manual 17" Ultra High Resolution LCD 1920 x 1200



X117

1U LCD Console Drawer

Options :

- SDI
- DC power



REACH

Legal Information

First English printing, October 2002

Information in this document has been carefully checked for accuracy; however, no guarantee is given to the correctness of the contents. The information in this document is subject to change without notice. We are not liable for any injury or loss that results from the use of this equipment.

Safety Instructions

Please read all of these instructions carefully before you use the device. Save this manual for future reference.

- Unplug equipment before cleaning. Don't use liquid or spray detergent; use a moist cloth.
- Keep equipment away from excessive humidity and heat. Preferably, keep it in an air-conditioned environment with temperatures not exceeding 40° Celsius (104° Fahrenheit).
- When installing, place the equipment on a sturdy, level surface to prevent it from accidentally falling and causing damage to other equipment or injury to persons nearby.
- When the equipment is in an open position, do not cover, block or in any way obstruct the gap between it and the power supply. Proper air convection is necessary to keep it from overheating.
- Arrange the equipment's power cord in such a way that others won't trip or fall over it.
- If you are using a power cord that didn't ship with the equipment, ensure that it is rated for the voltage and current labeled on the equipment's electrical ratings label. The voltage rating on the cord should be higher than the one listed on the equipment's ratings label.
- Observe all precautions and warnings attached to the equipment.
- If you don't intend on using the equipment for a long time, disconnect it from the power outlet to prevent being damaged by transient over-voltage.
- Keep all liquids away from the equipment to minimize the risk of accidental spillage. Liquid spilled on to the power supply or on other hardware may cause damage, fire or electrical shock.
- Only qualified service personnel should open the chassis. Opening it yourself could damage the equipment and invalidate its warranty.
- If any part of the equipment becomes damaged or stops functioning, have it checked by qualified service personnel.

What the warranty does not cover

- Any product, on which the serial number has been defaced, modified or removed.
- Damage, deterioration or malfunction resulting from:
 - Accident, misuse, neglect, fire, water, lightning, or other acts of nature, unauthorized product modification, or failure to follow instructions supplied with the product.
 - Repair or attempted repair by anyone not authorized by us.
 - Any damage of the product due to shipment.
 - Removal or installation of the product.
 - Causes external to the product, such as electric power fluctuation or failure.
 - Use of supplies or parts not meeting our specifications.
 - Normal wear and tear.
 - Any other causes which does not relate to a product defect.
- Removal, installation, and set-up service charges.

Regulatory Notices Federal Communications Commission (FCC)

This equipment has been tested and found to comply with the limits for a Class B digital device, pursuant to Part 15 of the FCC rules. These limits are designed to provide reasonable protection against harmful interference in a residential installation.

Any changes or modifications made to this equipment may void the user's authority to operate this equipment. This equipment generates, uses, and can radiate radio frequency energy and, if not installed and used in accordance with the instructions, may cause harmful interference to radio communications.

However, there is no guarantee that interference will not occur in a particular installation. If this equipment does cause harmful interference to radio or television reception, which can be determined by turning the equipment off and on, the user is encouraged to try to correct the interference by one or more of the following measures:

- Re-position or relocate the receiving antenna.
- Increase the separation between the equipment and receiver.
- Connect the equipment into an outlet on a circuit different from that to which the receiver is connected.

Contents

< Part. 1 > X117

1.1	Package Content	P.1
1.2	Structure Diagram & Dimension	P.1 - 2
1.3	Installation	P.3 - 5
1.4	Connection	P.6 - 9

< Part. 2 > Specifications / OSD

2.1	Product Specifications	P.10 - 11
2.2	Keyboard / Mouse Specifications	P.12 - 14
2.3	On-screen Display Operation (OSD)	P.15 - 16
2.4	Picture In Picture (PIP) / Picture By Picture (PBP)	P.17 - 18

< Part. 3 > Options

3.1	3G / HD / SD- SDI Broadcast-grade input	P.19
3.2	DC Power : 12V / 24V / 48V / 125V / 250V	P.20

< Part. 4 > KVM Integration

P.21

Before Installation

- It is very important to mount the equipment in a suitable cabinet or on a stable surface.
- Make sure the place has a good ventilation, is out of direct sunlight, away from sources of excessive dust, dirt, heat, water, moisture and vibration.

Unpacking

The equipment comes with the standard parts shown in package content. Check and make sure they are included and in good condition. If anything is missing, or damaged, contact the supplier immediately.

How To Clean Your LCD Monitor



Caution :

- To avoid the risk of electric shock, make sure your hands are dry before unplugging your monitor from or plugging your monitor into an electrical outlet.
- When you clean your monitor, do not press down on the LCD screen. Pressing down on the screen can scratch or damage your display. Pressure damage is not covered under warranty.
- Use only cleansers made specifically for cleaning monitors and monitor screens. Cleansers not made to clean monitors and monitor screens can scratch the LCD display or strip off the finish.
- Do not spray any kind of liquid directly onto the screen or case of your monitor. Spraying liquids directly onto the screen or case can cause damage which is not covered under warranty.
- Do not use paper towels or abrasive pads to clean your monitor. Using an abrasive pad or any wood based paper product such as paper towels can scratch your LCD screen.

Cleaning Your Monitor

To clean your LCD safely, please follow these steps :

- ① Disconnect the power cord.
- ② Gently wipe the surface using a clean, dry microfiber cloth. Use as little pressure as possible.

Cleaning Tough Marks and Smudges

To remove tough marks and smudges, please follow these steps :

- ① Disconnect the power cord.
- ② Spray a small amount of non-abrasive cleanser on a microfiber cloth.



Caution : Do not spray or apply any liquids directly onto the monitor. Always apply the solution to your microfiber cloth first, not directly on the parts you are cleaning.

- ③ Gently wipe the surface. Use as little pressure as possible.
- ④ Wait until your monitor is completely dry before plugging it in and powering it up.

< Part 1 >

< 1.1 > Package Content



X117 unit X 1

- CX-6 6ft DVI-D console cable X 1
(Alternative : CB-6 6ft VGA console cable)
- Power cord X 1
- M6 screw, cage nut & cup washer X 8



The above package content is only for the single console models.
It varies with options such as KVM, SDI & DC power.

< 1.2 > Structure Diagram

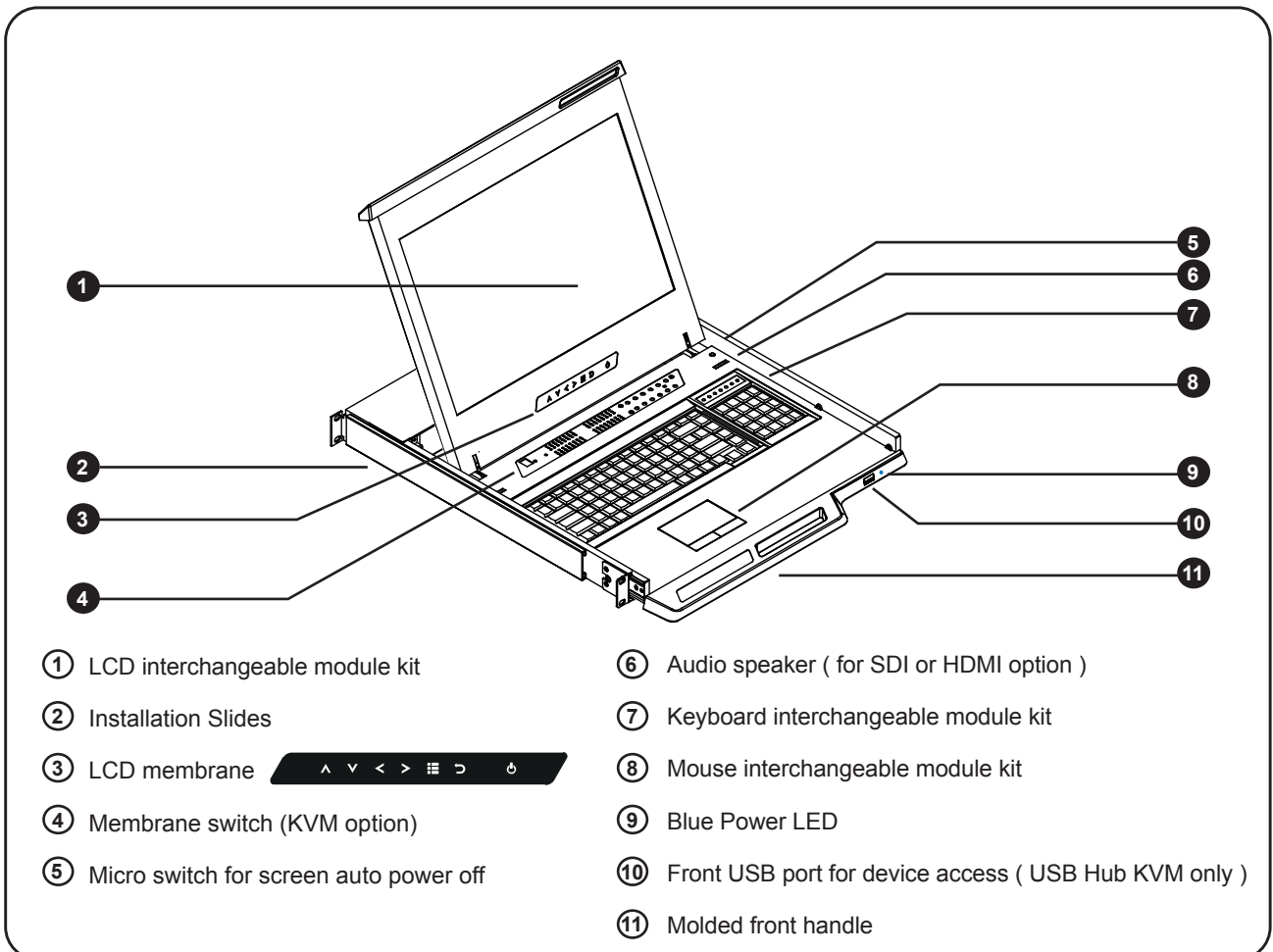

< 1.2 > Dimension

X117

Front View

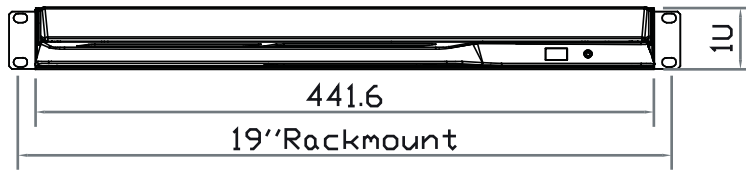

Rear View

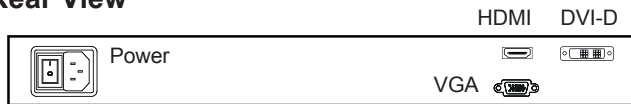

Side View

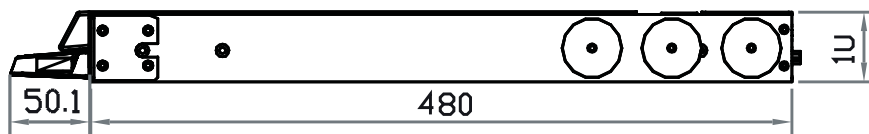

UNIT : mm
1mm = 0.03937 inch

Top View

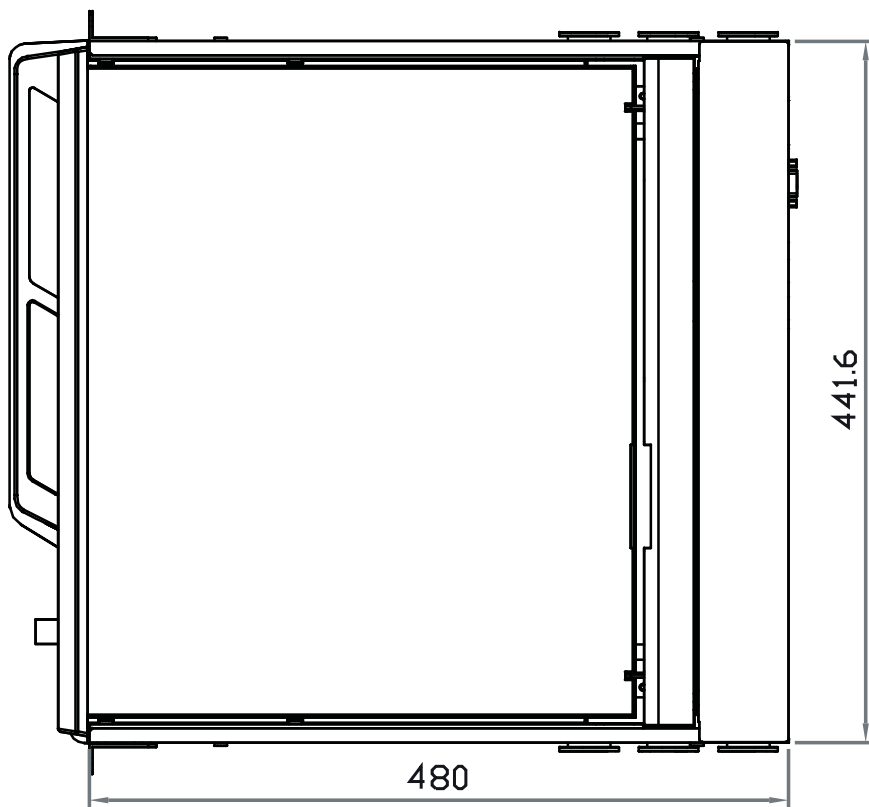

Model	Product Dimension (W x D x H)	Packing Dimension (W x D x H)	Net Weight	Gross Weight
X117	441.6 x 480 x 44 mm 17.4 x 18.9 x 1.73"	590 x 808 x 140 mm 23.2 x 31.8 x 5.5"	10.9 kg 24 lb	15.8 kg 34.8 lb

! The weight is only for the single console models. It varies with accessories & options such as KVM, SDI, HDMI & DC power.

< 1.3 > Installation - Installation Slides

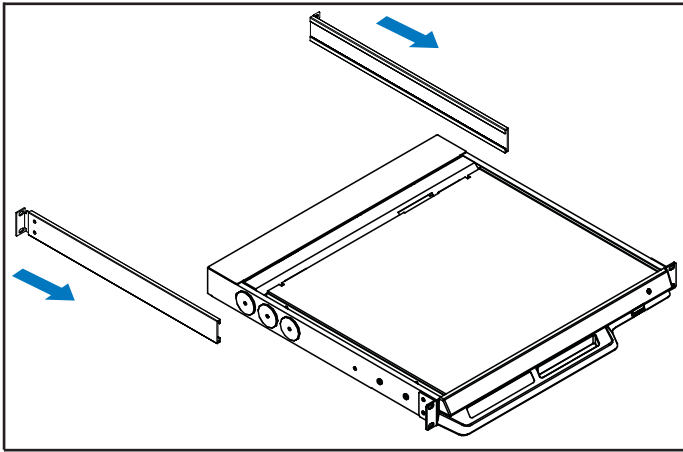

Step 1

- Insert the left and right rear mounting brackets into the LCD console drawer.

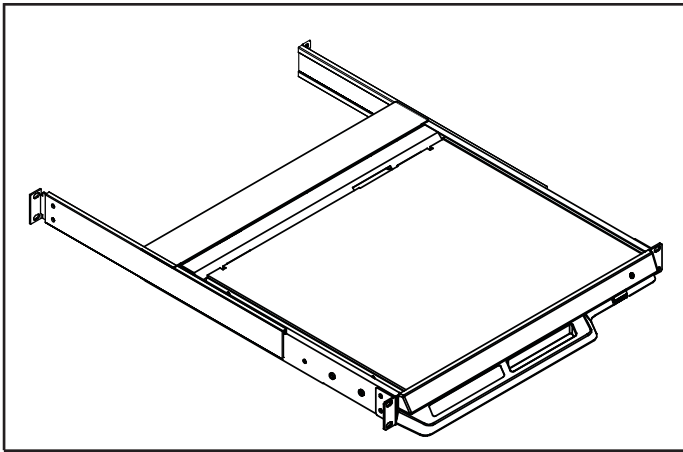

Step 2

- Measure the depth of the front and rear mounting rails.
- Align each rear mounting bracket to a suitable length.

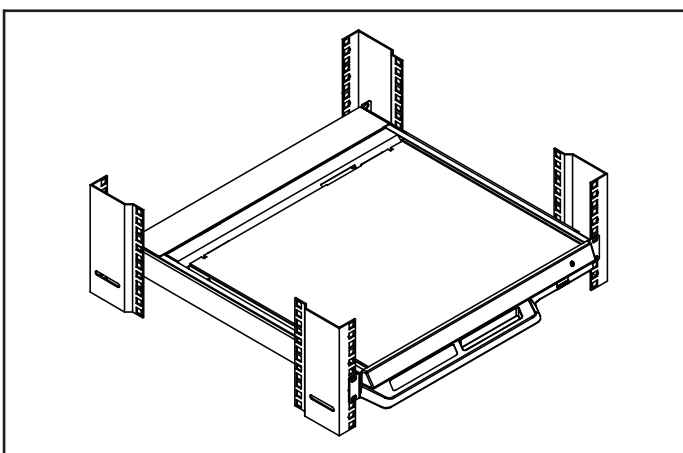

Step 3

Complete the installation

- Fix the LCD console drawer into the rack.



M6 screw, cage nut & cup washer x 8 are provided.

< 1.3 > Installation - **ORB-2.1** 2-Post Rack Mounting Brackets (Option) X117

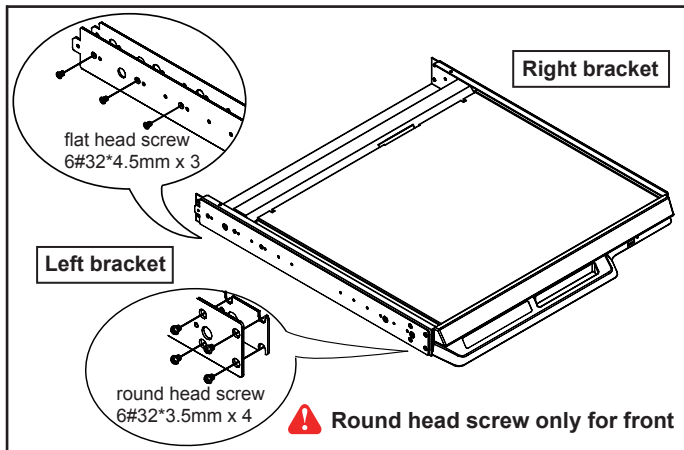

Step 1

- Before apply 2-post rack brackets, please release front mounting ears and rear mounting wheels.
- Attach **left and right mounting brackets** to the drawer with the screws below :
6#32*3.5 mm screw x 8 (only for front)
6#32*4.5 mm screw x 6 (only for rear)

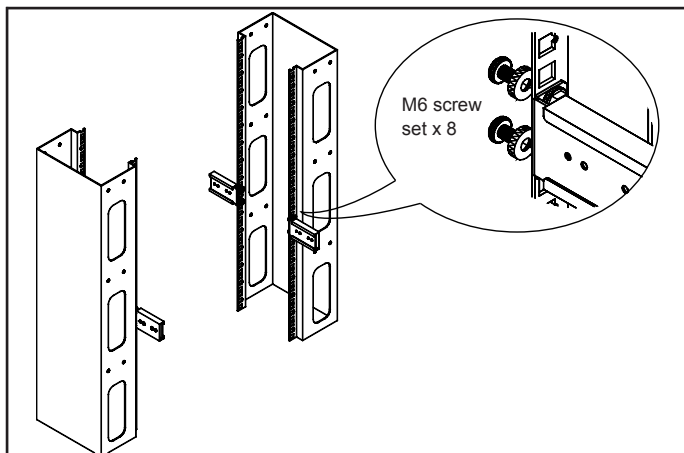

Step 2

- Attach the set of 4 mini brackets to the 2-post rack.
- M6 screw set is not provided.

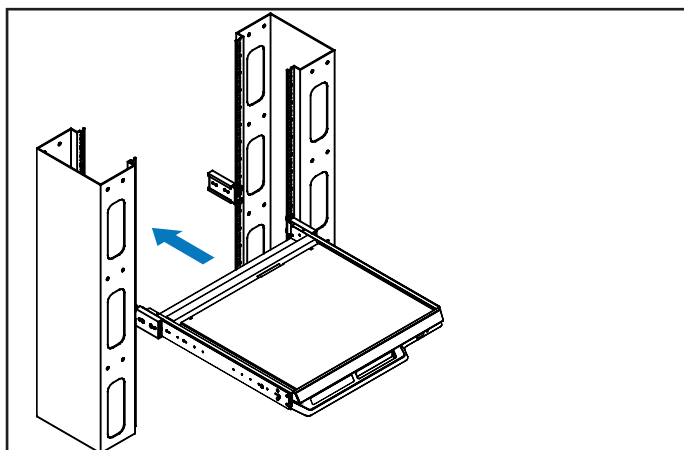

Step 3

- Insert the drawer into the mini brackets.

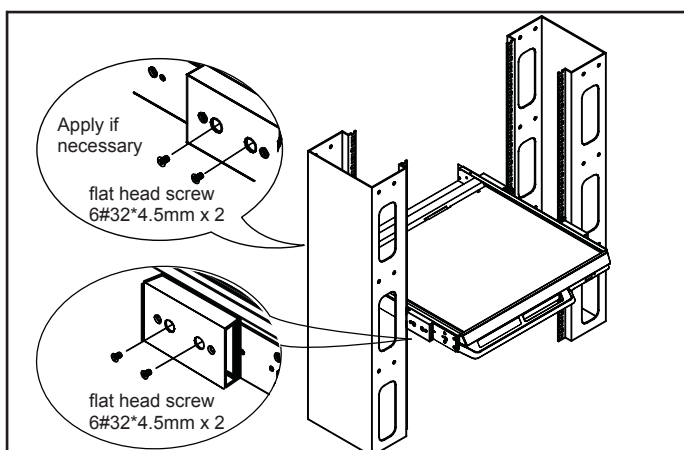

Step 4

- Fix the LCD console drawer to the mini brackets with 6#32*4.5 mm screw x 8.
- Installation completed

! This step is necessary for front.
Failure to complete this will cause damage.

< 1.3 > Installation- How to use the drawer



- Hold the handle and slide out the drawer.



- Flip up the LCD to a suitable angle.



- Operate the LCD console drawer.

X117 provides three signal input - DVI-D, VGA & HDMI. By PIP function, user can view two different signal inputs on the display (please refer to P.17-18).

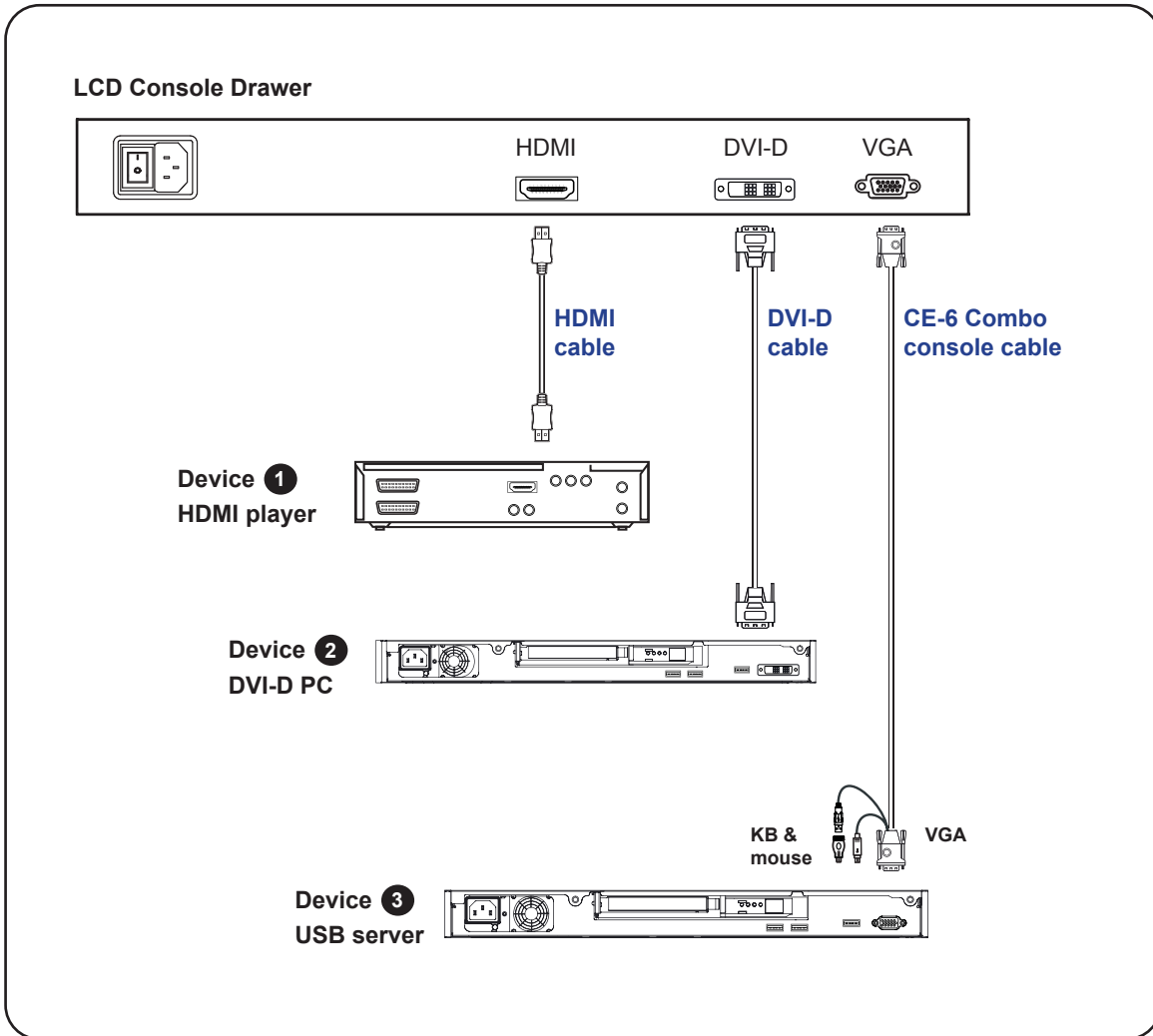

Caution : The LCD console drawer is hot-pluggable, but components of connected devices, such as the servers and KVM switch, may not be hot-pluggable. Plugging and unplugging cables while servers and KVM are powered on may cause irreversible damage to the servers, KVM and LCD console drawer. Before attempting to connect anything to the LCD console drawer, we suggest turning off the power to all devices. Apply power to connected devices again only after the LCD console drawer is receiving power. The company is not responsible for damage caused in this way.

< 1.4 > Connection to **USB Server** via CX-6 cable

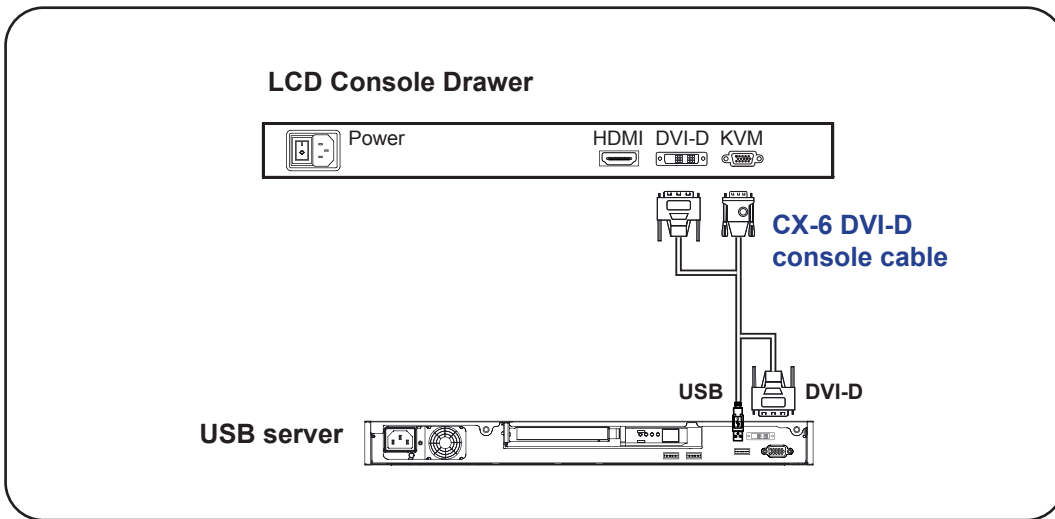

< 1.4 > Connection to **external KVM** via CX-6 cable

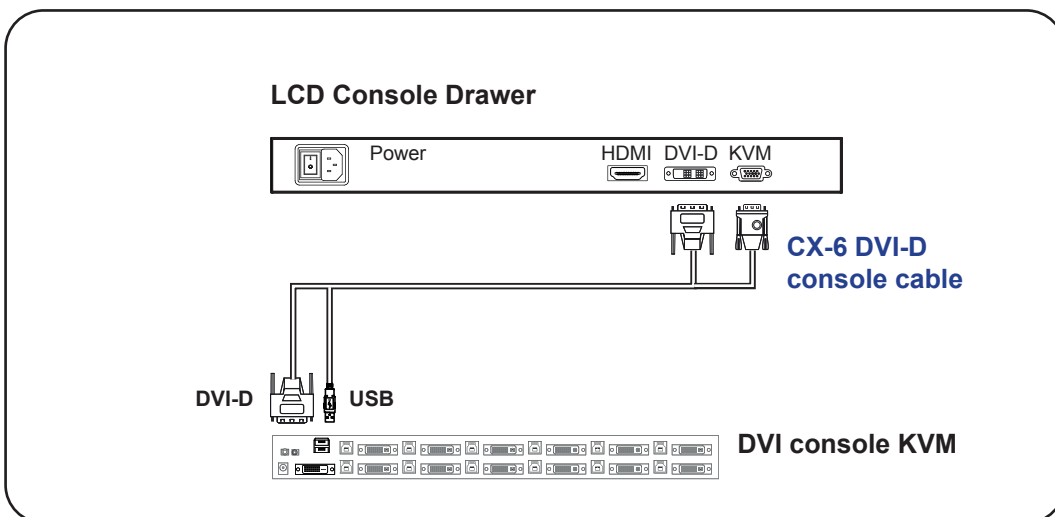

Caution : The LCD console drawer is hot-pluggable, but components of connected devices, such as the servers and KVM switch, may not be hot-pluggable. Plugging and unplugging cables while servers and KVM are powered on may cause irreversible damage to the servers, KVM and LCD console drawer. Before attempting to connect anything to the LCD console drawer, we suggest turning off the power to all devices. Apply power to connected devices again only after the LCD console drawer is receiving power. The company is not responsible for damage caused in this way.

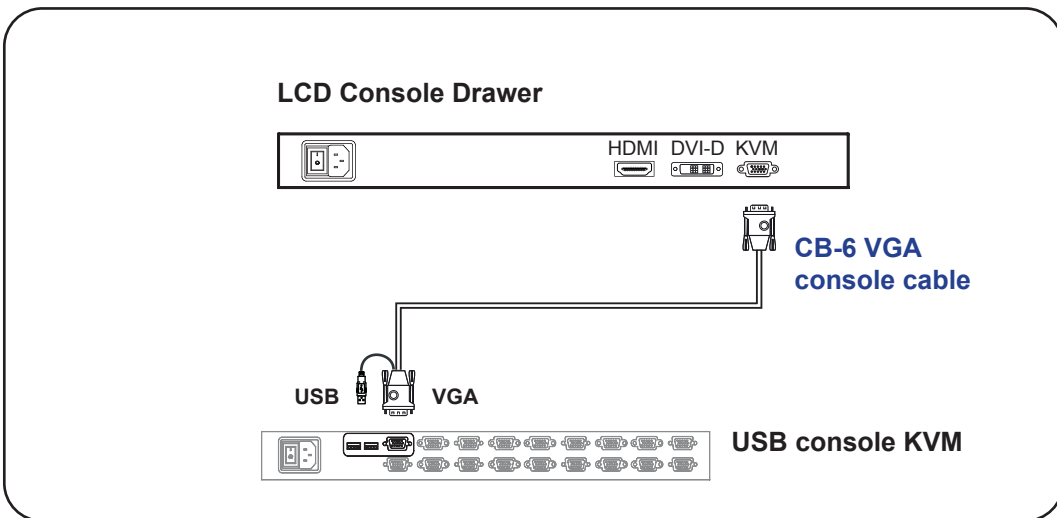
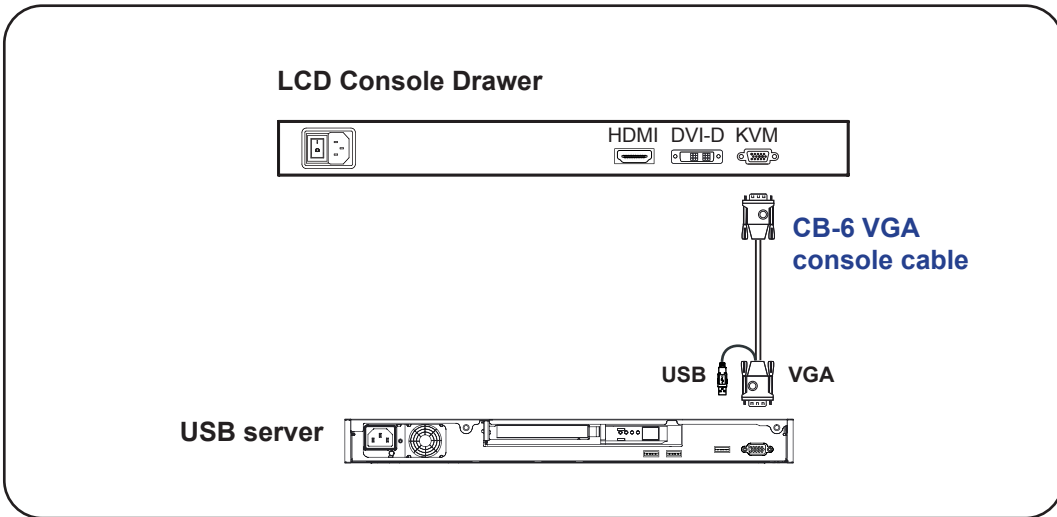

Caution : The LCD console drawer is hot-pluggable, but components of connected devices, such as the servers and KVM switch, may not be hot-pluggable. Plugging and unplugging cables while servers and KVM are powered on may cause irreversible damage to the servers, KVM and LCD console drawer. Before attempting to connect anything to the LCD console drawer, we suggest turning off the power to all devices. Apply power to connected devices again only after the LCD console drawer is receiving power. The company is not responsible for damage caused in this way.

< 1.4 > Connection to **HDMI Device** via *HDMI cable

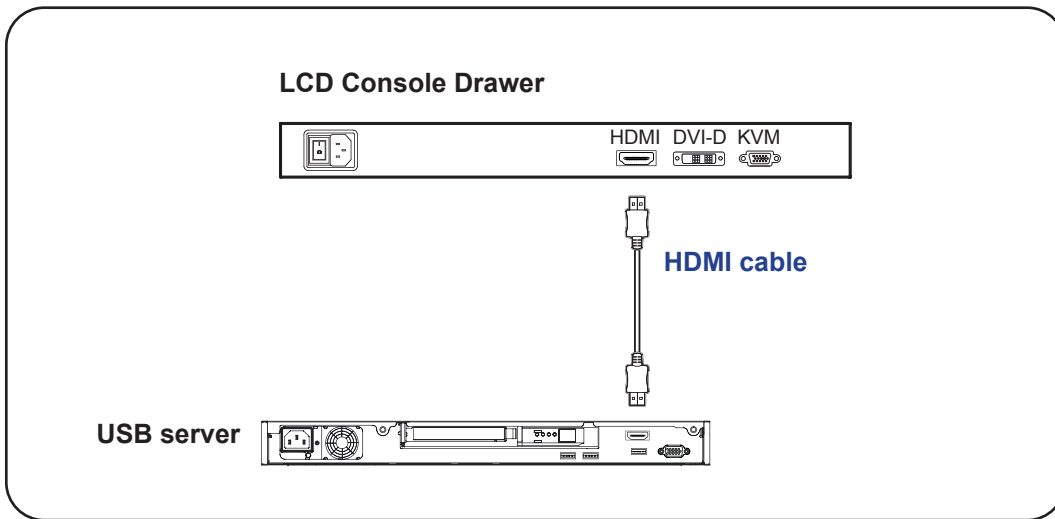

* HDMI cable is not provided.



Caution : The LCD console drawer is hot-pluggable, but components of connected devices, such as the servers and KVM switch, may not be hot-pluggable. Plugging and unplugging cables while servers and KVM are powered on may cause irreversible damage to the servers, KVM and LCD console drawer. Before attempting to connect anything to the LCD console drawer, we suggest turning off the power to all devices. Apply power to connected devices again only after the LCD console drawer is receiving power. The company is not responsible for damage caused in this way.

LCD Panel	Panel Size (diagonal)	17.1-inch Widescreen TFT color LCD
	Display pixel (dots x lines)	1920 x 1200
	Brightness (typ.)	210
	Contrast Ratio (typ.)	600:1
	Color	16.7 M, 8-bit
	Viewing Angle (L/R/U/D)	65/65/55/55
	Response Time (ms)	30
	Dot pitch (mm)	0.191
	Display Area (mm)	367.20H x 229.50V
	Surface treatment	Anti-glare, Hard-coating
	Surface hardness	3H
	Backlight Type	LED
	MTBF (hrs)	20,000

Video Connectivity	Digital	HDMI	HDMI 1.3, CEA-861-D
		DVI	DVI-D, TMDS single link
	Analog	VGA	Analog 0.7Vp-p
	Plug & Play	DVI / VGA	VESA EDID structure 1.3
	Synchronization	VGA	Separate, Composite & SOG

Power	Power Supply	Range	Auto-sensing 100 to 240VAC, 50 / 60Hz
	Power Consumption for Single Console	Screen ON	Max. 34W
		Power saving mode	Max. 4W
		Power button OFF	Max. 1W
	Power Consumption with KVM integration	Screen ON	Max. 59W
		Power saving mode	Max. 29W

*For details, please refer to our KVM rear kit user manuals

Regulatory	Safety	FCC & CE certified
	Environmental	RoHS2 & REACH compliant

Environmental Conditions	Operating	Temperature	0 to 55°C degree
		Humidity	20~90%, non-condensing
		Altitude	16,000 ft
	Storage / Non-operating	Temperature	-20 to 60°C degree
		Humidity	5~90%, non-condensing
		Altitude	40,000 ft
		Shock	10G acceleration (11ms duration)
		Vibration	5~500Hz 1G RMS random

Physical Specification	Product (W x D x H)	441.6 x 480 x 44 mm 17.4 x 18.9 x 1.73 inch
	Packing (W x D x H)	590 x 808 x 140 mm 23.2 x 31.8 x 5.5 inch
	Net Weight	10.9 kgs / 24 lbs
	Gross Weight	15.8 kgs / 34.8 lbs

Applicable Format	DVI-D / VGA Input	PC Signal	1920 x 1200 x 60Hz
			1360 x 768 x 60Hz
			1280 x 1024 x 60 / 75Hz
			1280 x 960 x 60Hz
			1280 x 768 x 60 / 75Hz
			1152 x 864 x 75Hz
			1024 x 768 x 60 / 70 / 75Hz
			848 x 480 x 60Hz
			800 x 600 x 60 / 72 / 75Hz
			720 x 400 x 70Hz
			640 x 480 x 60 / 72 / 75Hz
			640 x 400 x 70Hz
	640 x 350 x 70Hz		
	HDMI Input	PC Signal	Same as VGA
			Video Signal
720p : 50 / 60Hz			
480p : 60Hz			
HDMI Input	Audio Signal	576p : 50Hz	
		2ch Linear PCM (32 / 44.1 / 48 KHz)	
HDMI Input	Speaker	Dual Stereo Speaker, 2 x 2W	

*In some circumstances, if the user connects the LCD to PC via HDMI port for video and audio signals, the LCD may display incorrectly on a full screen. If so, please adjust the display card setting on display size to fix the issue.

Ge G keyboard integrated with touchpad

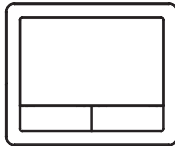
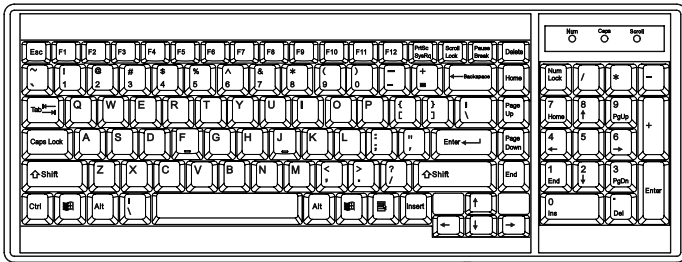

Gb G keyboard integrated with trackball

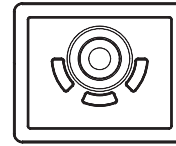
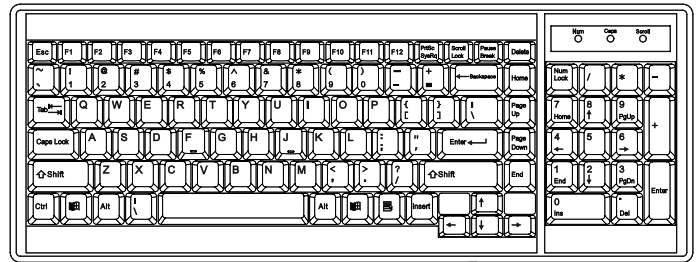

Key force	55 ± 5g
Travelling distance	3 ± 0.3mm
Switch life	> 10 million life cycle time
OS support	Windows / Linux / Unix / Mac OS

Supporting layouts

America



United States



United Kingdom



Germany



France



Spain



Norway

EMEA



Italy



Russia



Switzerland



Netherlands



Portugal

Asia



China



Japan



Korea



Arabia



Turkey

< 2.2 > MAC Keyboard / Mouse Options

Me MAC keyboard integrated with touchpad

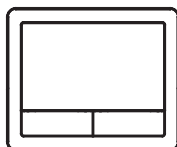
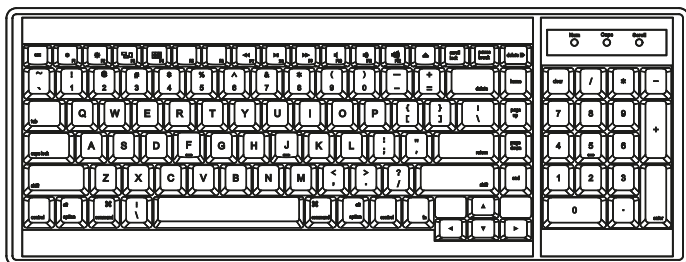

Mb MAC keyboard integrated with trackball

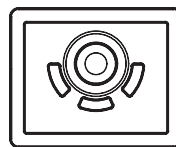
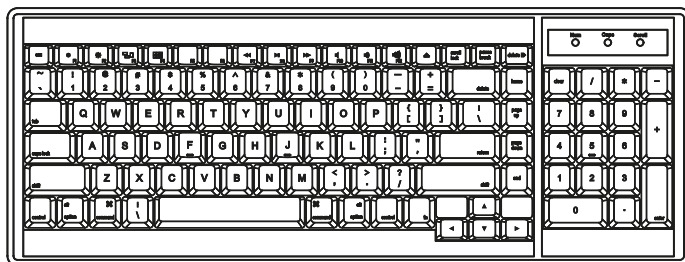

Supporting layouts

America 
United States

How to Use "MAC" Keyboard

Keyboard Features



F1
Decrease display brightness



F9
Fast-forward

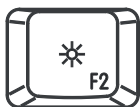

F2
Increase display brightness



F10
Mute sound

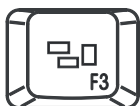

F3
Mission control
* Only works with OS X Lion
default Keyboard Shortcuts.



F11
Decrease volume



F4
Dashboard



F12
Increase volume



F7
Rewind

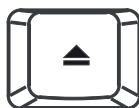

Eject disc



F8
Play / Pause



Command

Se S keyboard integrated with touchpad

Sb S keyboard integrated with trackball

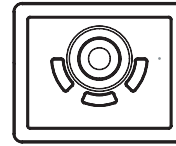
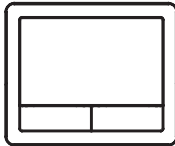
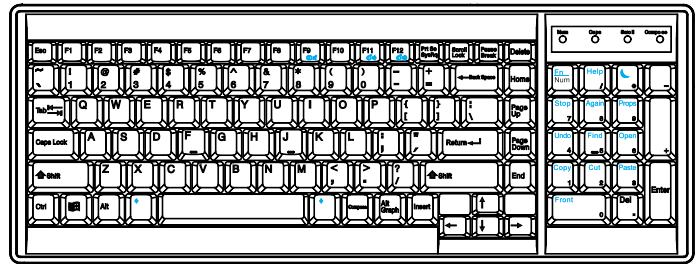
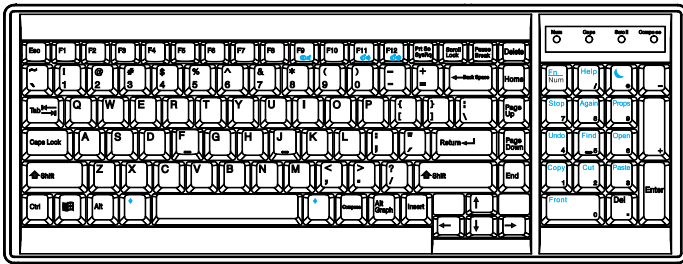

S keyboard integrated with touchpad / trackball



- Incorporates SUN keys, including Stop, Cut, Paste, Compose, Copy and Help
- 104 key notepad keyboard with full numerical pad and SUN function
- USB interface
- US layout only

How to Use "S" Keyboard

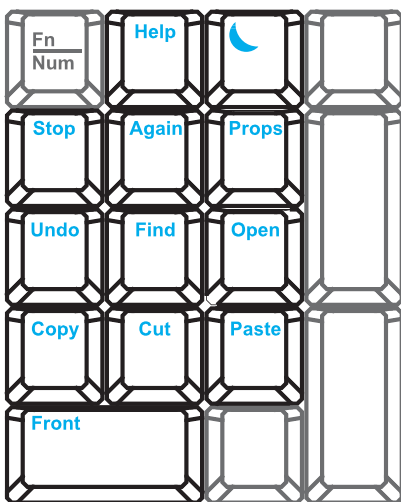

Num LED in Off mode

Key pad behaves as a SUN Solar system administration command mode

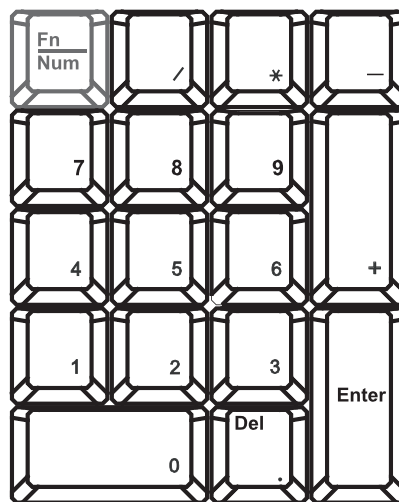

Num LED in Green mode

Key pad behaves as a normal key pad mode

Audio / Display Keys

* Please ask your supplier for full details

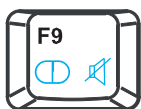

F9
Audio : Mute
Display : Degauss

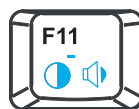



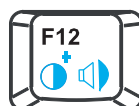

F11
Audio : Decrease volume
Display : Decrease contrast



F12
Audio : Increase volume
Display : Increase contrast

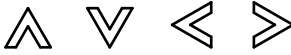

< 2.3 > On-screen Display Operation (OSD)



Membrane Switch	Function
	Turn the monitor on or off
	Display the OSD menu Act as an Enter key to select screen setting options
	Scroll through menu options and adjust the displayed control
	Exit the OSD screen Go back to the previous on-screen sub-menu or main menu

Remark : All LED touch buttons in **WHITE** light.

The LED of **Power**  touch button will flash continuously when there is no signal input.

- ① All the LED touch buttons will automatically turn off after 10 minutes of idle status (except the **Power** ).
- ② Light up all membrane buttons, please press any button for 1 - 2 seconds (except the **Power** ).

① Picture

Picture mode :	Standard / Vivid / Soft / User mode to choose
Brightness :	Adjust background black level of the screen image
Contrast :	Adjust the difference between the image background (black level) and the foreground (white level)
Hue:	Adjust the screen hue value
Saturation :	Adjust the saturation of the image color
Picture size :	Adjust the image size
Color temp :	Standard / Cool / Warm / User to choose
Noise reduce :	Reduce the noise of the image
Sharpness :	Adjust the image from weak to sharp

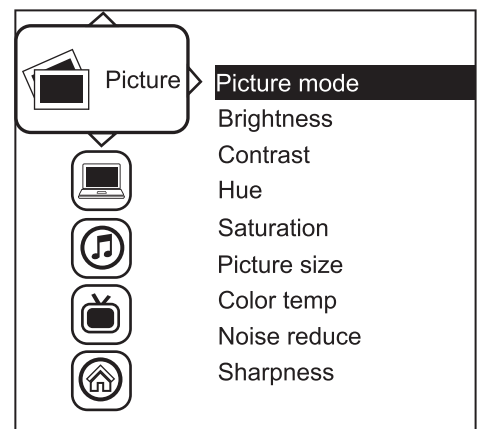

② PC

- Auto adjust : Automatically adjust sizes, centers and fine tunes the video signal to eliminate waviness and distortion.
- Clock : Adjust the clock value
- Phase : Adjust the phase value
- H. Position : Align the screen image left or right
- V. Position : Align the screen image up or down

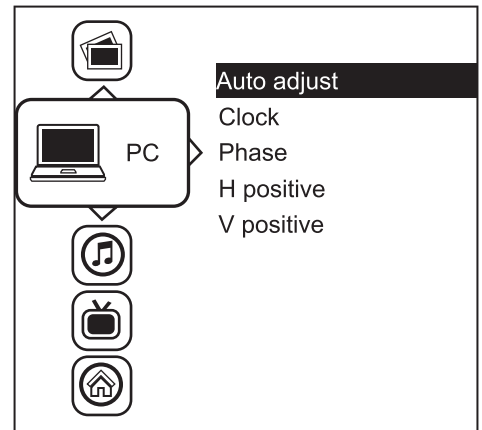

③ Audio

- Audio mode : Movie / Voice / Normal / Music mode to choose
- Volume : Adjust the volume of sound
- Bass : Set the value of bass sound
- Treble : Set the value of treble sound
- Balance : Set the balance value of treble and bass sound
- Analog TV audio : Set the value of analog TV audio sound
- Mute : Turn off the surrounding sound

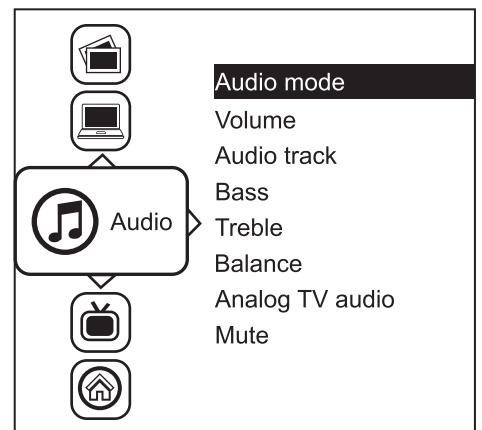

④ MISC

- Language : Select the language in which the OSD menu is displayed - English
- Sleep timer : Set the off time
- PIP mode : Adjust picture in picture setting
- PIP position : Enter into PIP position
- PIP source : Enter into the Sub source and sound source
- System reset : Return the adjustment back to factory setting
- Information : Select for Help

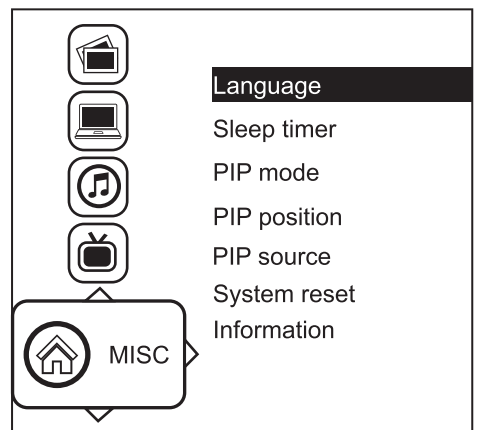

< 2.4 > How to Use Picture In Picture (PIP) / Picture By Picture (PBP)

< 2.4.1 > Picture in Picture (PIP)

Mode

Display the Sub screen in the Main screen.

OSD Menu → MISC → PIP Mode → Large / Small / OFF

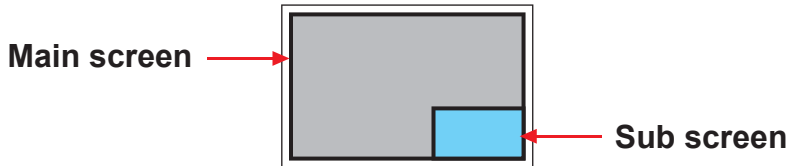

Position

Adjust the position of the Sub screen (top left, bottom left, top right, bottom right)

OSD Menu → MISC → PIP Position → top left / top right / bottom left / bottom right

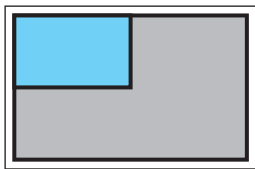

top left

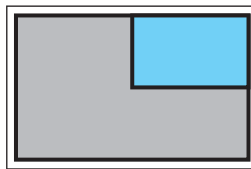

top right

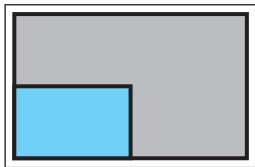

bottom left

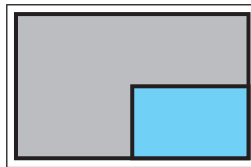

bottom right

Size

Adjust the size of the Sub screen (Large / Small)

OSD Menu → MISC → PIP Mode → Large / Small

Size of Sub screen

LCD Monitor	Large Sub screen	Small Sub screen
1920 x 1200	552 x 414	480 x 360
1920 x 1080	552 x 414	480 x 360
1440 x 900	414 x 310	360 x 270
1366 x 768	392 x 294	340 x 254
1280 x 1024	368 x 276	320 x 240

< 2.4.2 > Picture By Picture (PBP)

Mode

Display the Sub screen next to the Main screen.

OSD Menu → MISC → PIP Mode → PBP



Size

LCD Monitor	Main / Sub screen
1920 x 1200	955 x 716
1920 x 1080	955 x 716
1440 x 900	715 x 536
1366 x 768	678 x 508
1280 x 1024	635 x 476

< 2.4.3 > PIP / PBP Source

To select an input signal for PIP / PBP Sub screen.

OSD Menu → MISC → PIP Source → VGA / S-Video / Composite / DVI / HDMI / SDI / YPbPr / TV

The PIP / PBP is operable in the following table :

Main \ Sub	VGA	S-Video	Composite	DVI-D	HDMI	SDI	YPbPr	TV
VGA	X	O	O	O	O	O	O	O
S-Video	O	X	X	O	O	O	O	X
Composite	O	X	X	O	O	O	O	X
DVI	O	O	O	X	X	O	O	O
HDMI	O	O	O	X	X	O	O	O
SDI	O	O	O	O	O	X	X	O
YPbPr	O	O	O	O	O	X	X	O
TV	O	X	X	O	O	O	O	X

< Part 3 >

< 3.1 > Options : 3G / HD / SD-SDI input



Austin Hughes' SDI input is an ideal solution for the broadcast-grade video and high resolution CCTV market.

Designed for use with CyberView displays, a SDI input module can support up to 1080p @60Hz resolution without using additional space or power and it comes standard with a 2-year warranty.

SDI

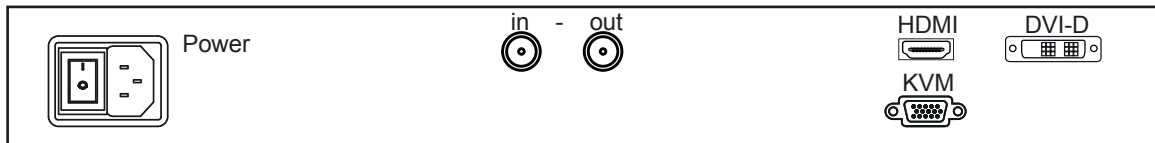

*** For SDI option, casing depth will be changed from 480mm (18.9") to 530mm (20.9")

INPUT	3G-SDI IN	BNC x 1 / 0.8Vp-p (75 ohm)
	3G-SDI OUT	BNC x 1 / Active through, equalized & relocked

Standard Compliance	Video	SMPTE 425M / 274M / 296M / 125M ITU-R BT.656
	Audio	SMPTE 299M / 272M-C

Compatible Video Format	3G-SDI	1080p @60 / 50Hz, 4:2:2
		1080p @30 / 25 / 24Hz, 4:4:4
		1080i @60 / 50Hz, 4:4:4
		720p @60 / 50Hz, 4:4:4
	HD-SDI	1080p @30 / 25 / 24Hz, 4:2:2
		1080i @60 / 50Hz, 4:2:2
		720p @60 / 50Hz, 4:2:2
SD-SDI	480i @60Hz, 4:2:2	
ITU-R BT.656	576i @50Hz, 4:2:2	

Compatible Audio Format	3G-SDI	48kHz, 16 / 20 / 24 bit, 2 CH, Synchronized Video
	HD-SDI	48kHz, 16 / 20 / 24 bit, 2 CH, Synchronized Video
	SD-SDI	48kHz, 16 / 20 / 24 bit, 2 CH, Synchronized / Asynchronized Video

Max. Transmission Distance 75 ohm coaxial cable	3G-SDI	150m at 2.97Gb/s
	HD-SDI	250m at 1.485Gb/s
	SD-SDI	480m at 270Mb/s

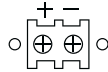

Model	12V	24V	48V	125V	250V
Input rating					
Input voltage:	12-Volt	24-Volt	48-Volt	110-Volt	300-Volt
Input range:	9 ~ 18V	18 ~ 36V	36 ~ 75V	66 ~ 160V	180 ~ 425V
Input current					
- No load	50 mA	50 mA	50 mA	35 mA	10 mA
- Full load	4950 mA	2450 mA	1220 mA	749 mA	600 mA
Output rating					
Output voltage:	12-Volt	12-Volt	12-Volt	12-Volt	12-Volt
Output current:	4.16A	4.16A	4.16A	6.25A	12.5A
Efficiency	84%	85%	85%	91%	86%

DC power





*** For DC power option :



- (1) If the unit with LCD, **earthing** may be required 
- (2) DC option excludes AC power adapter and power cord.
- (3) Casing depth will be extended from 480mm (18.9") to 530mm (20.9")

< Part. 4 > KVM Integration



www.austin-hughes.com/support/usermanual/cyberview/UM-CV-MKVM-KIT.pdf

Matrix DB-15 KVM 	Local	Remote		8-port	16-port	32-port
	1	1	1	-MIP813	-MIP1613	-
	1	1	2	-MIP824	-MIP1624	-
	1	1	0	-M802	-M1602	-
	1	2	0	-M803	-M1603	-
	1	3	0	-M804	-M1604	-



www.austin-hughes.com/support/usermanual/cyberview/UM-CV-SKVM-KIT.pdf

Combo DB-15 KVM 	Local	Remote		8-port	16-port	32-port
	1	0	1	-IP802	-IP1602	-
	1	1	0	-802	-1602	-
	1	0	0	-S801	-S1601	-

www.austin-hughes.com/support/usermanual/cyberview/UM-CV-DVIKVM-KIT.pdf

DVI-D KVM 	Local	Remote		12-port	-	-
	1	0	0	-1201D	-	-

www.austin-hughes.com/support/usermanual/cyberview/UM-CV-USBKVM-KIT.pdf

USB Hub DB-15 KVM 	Local	Remote		8-port	16-port	32-port
	1	0	1	-IP802H	-IP1602H	-
	1	1	0	-802H	-1602H	-
	1	0	0	-801H	-1601H	-

Model	Product Dimension (W x D x H)	Packing Dimension (W x D x H)	Net Weight	Gross Weight
X117 with KVM	441.6 x 580 x 44 mm 17.4 x 22.8 x 1.73"	590 x 808 x 140 mm 23.2 x 31.8 x 5.5"	12.1 kg 26.6 lb	18.1 kg 39.8 lb

The company reserves the right to modify product specifications without prior notice and assumes no responsibility for any error which may appear in this publication.

All brand names, logo and registered trademarks are properties of their respective owners.